



Instructions for use for ENA Micro 5

Your ENA Micro 5

Control elements	30
Important information	32
Proper use	32
For your safety	32
1 Preparing and using for the first time	34
Setting up the machine	34
Filling the bean container	34
First-time use.....	35
First-time use with filter cartridge activation	35
First-time use without filter cartridge activation	36
Filling the water tank	36
Determining the water hardness	36
2 Preparation	37
Rotating coffee spout	37
Ristretto, espresso and coffee	37
Permanently setting the amount of water for the cup size.....	38
Adjusting the grinder	38
Ground coffee	39
3 Daily operation	39
Switching on the machine	39
Daily maintenance.....	40
Switching off the machine	40
4 Permanent settings in programming mode	40
Inserting and activating the filter	40
Setting the water hardness	41
5 Maintenance	41
Cleaning the machine	41
Descaling the machine	42
Changing the filter.....	43
Descaling the water tank.....	44
Cleaning the bean container	44
6 Messages on symbol display	45
7 Troubleshooting	46
8 Transport and environmentally friendly disposal	47
Transport / Emptying the system	47
Disposal	47
9 Technical data	47
10 Index	48
11 JURA contact details / Legal information	50

Symbol description

Warnings

⚠ WARNING	Always take note of any information marked with the words CAUTION or WARNING and a warning sign. The signal word WARNING draws your attention to potential serious injury, and the signal word CAUTION to potential minor injury.
⚠ CAUTION	
CAUTION	CAUTION draws your attention to potential damage to the machine.

Symbols used

▶	Prompt to take action. This symbol means that you are being prompted to perform some action.
i	Information and tips to make it even easier to use your ENA.

Control elements

Control elements

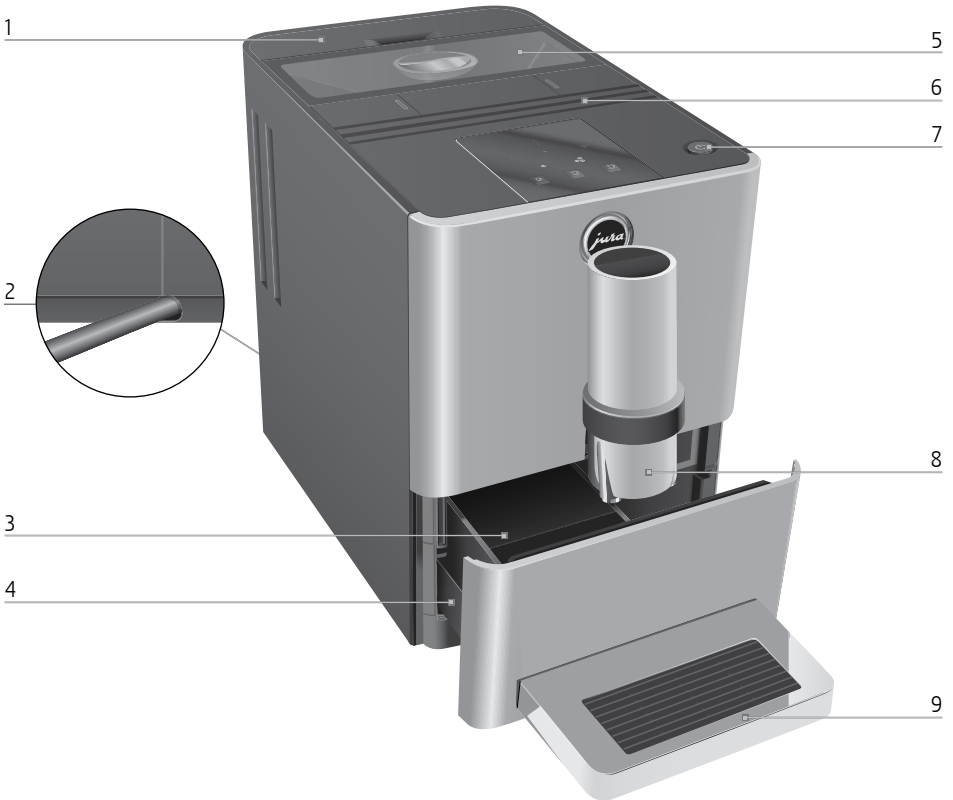

- 1 Water tank
- 2 Mains cable (back of the machine)
- 3 Coffee grounds container
- 4 Drip tray
- 5 Bean container with aroma preservation cover
- 6 Ventilation slots
- 7 On/Off button
- 8 Rotating coffee spout (height-adjustable)
- 9 Cup grille

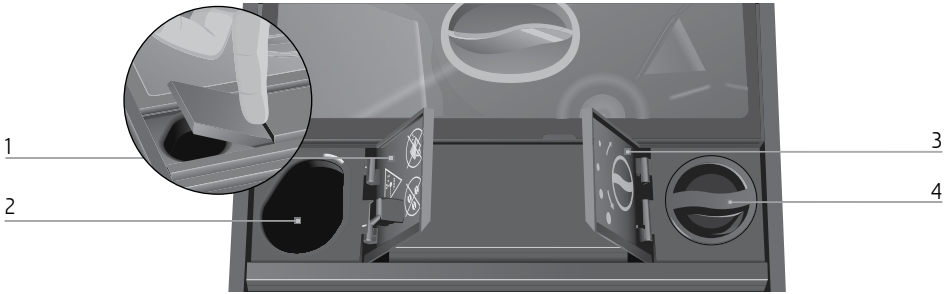

- 1 Cover for powder chute for ground coffee
2 Powder chute for ground coffee

- 3 Cover cap for grinder adjustment switch
4 Grinder adjustment switch

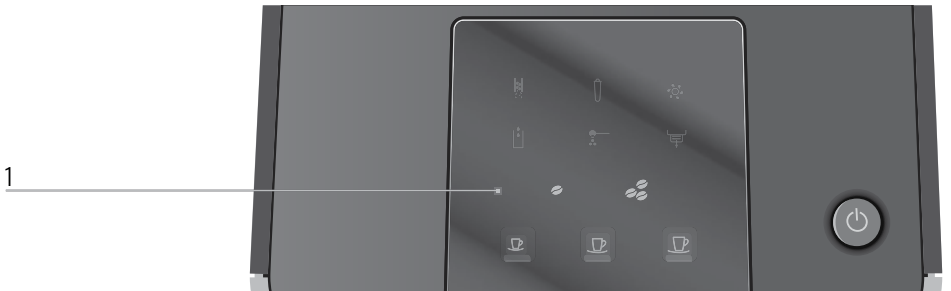

- 1 Symbol display
- Descaling symbol
 - Filter symbol
 - Cleaning symbol
 - Water Tank symbol
 - Ground Coffee symbol
 - Coffee Grounds Container symbol

- Coffee strength 'normal'
- Coffee strength 'strong'
- Ristretto symbol
- Espresso symbol
- Coffee symbol

Important information

Proper use

The machine is designed and intended for private domestic use. It is designed solely for the preparation of coffee. Use for any other purpose will be deemed improper. JURA Elektroapparate AG cannot accept any responsibility for the consequences of improper use.

Before using the machine read these instructions for use thoroughly and completely and comply with the instructions they contain. A warranty service is not applicable for damage or defects caused by non-compliance with the instructions for use. Keep these instructions for use close to the machine and pass them on to the next user.

For your safety

Please carefully read and observe the important safety information set out below.

To avoid danger of potentially fatal electric shock:

- Never use a machine which is damaged or has a defective mains cable.
- In the event of signs of damage, for example if there is a smell of

burning, unplug the machine immediately from the mains supply and contact JURA service.

- If the mains cable of this machine is damaged, it must be repaired either directly by JURA or by an authorised JURA service centre.
- Make sure that the ENA and the mains cable are not located close to hot surfaces.
- Be careful to ensure that the mains cable is not trapped and does not rub against sharp edges.
- Never open and repair the machine yourself. Do not modify the machine in any way that is not described in these instructions for use. The machine contains live parts. If opened, there is a danger of potentially fatal injury. Repairs may only be carried out by authorised JURA service centres, using original spare parts and accessories.

A defective machine is not safe and could cause injury or fire. To avoid damage and any associated risk of injury or fire:

- Never allow the mains cable to loosely hang down. The mains cable could pose a tripping hazard or become damaged.

- Protect the ENA from environmental influences such as rain, frost and direct sunlight.
 - Do not immerse the ENA, mains cable or connections in water.
 - Do not put the ENA or any individual parts in the dishwasher.
 - Switch your ENA off before cleaning work with the On/Off button. Always wipe the ENA with a damp cloth rather than a wet one, and protect it from prolonged exposure to water splash.
 - Only connect the machine to the mains voltage in accordance with the information on the rating plate. The rating plate is located on the underside of your ENA. Further technical data is provided in these instructions for use (see Chapter 9 'Technical data').
 - Please only use original JURA maintenance products. Use of products that are not explicitly recommended by JURA could damage the ENA.
 - Do not use any coffee beans treated with additives or caramelised coffee beans.
 - Only fill the water tank with fresh, cold water.
- Do not fill the bean container with water.
 - Switch the machine off with the On/Off button if you are going to be absent for a longer period of time and remove the mains plug from the power socket.
 - Children may not clean or service the machine unless supervised by a responsible person.
 - Do not allow children to play with the machine.
 - Keep children under the age of 8 away from the machine, or supervise them constantly.
 - Children aged 8 and over may only operate the machine without supervision if they have been instructed in how to use it safely. Children must be able to recognise and understand the potential dangers arising from incorrect use.

People, including children, who

- do not have the physical, sensory or mental capabilities to use the machine safely or
- are inexperienced or lack knowledge in how to use the machine safely

must be supervised by a responsible person when using it, or must be instructed in how to use it correctly.

Safety when handling the CLARIS Blue filter cartridge:

- Filter cartridges should be kept out of the reach of children.
- Store filter cartridges in a dry place in the sealed packaging.
- Protect cartridges from heat and direct sunlight.
- Do not use damaged filter cartridges.
- Do not open filter cartridges.

1 Preparing and using for the first time

This chapter provides you with the information you need to use your ENA without any problems. You will prepare your ENA step-by-step to enjoy your first perfect cup of coffee.

- i** Visit us on the internet. On the **JURA website** (www.jura.com) you will find interesting and up-to-date information on your ENA and every aspect of coffee.

Setting up the machine

When setting up your ENA, please note the following:

- Place the machine on a horizontal surface that is not sensitive to water.
- Choose a spot for your ENA which protects the machine against overheating. Ensure that the ventilation slots are not covered.

Filling the bean container

CAUTION

Coffee beans which have been treated with additives (e.g. sugar), ground coffee or freeze-dried coffee will damage the grinder.

- ▶ Only use roasted, untreated coffee beans to fill the bean container.
-
- ▶ Remove the aroma preservation cover of the bean container.
 - ▶ Remove any dirt or foreign objects from inside the bean container.
 - ▶ Fill the bean container with coffee beans.
 - ▶ Close the bean container.

First-time use

When using the machine for the first time, you can choose whether you want to operate ENA **with** or **without** the CLARIS Blue filter cartridge. If the water hardness is 10 °dH or more, we recommend using the filter cartridge. If you do not know the hardness of your water, you can find this out first (see Chapter 1 'Preparing and using for the first time – Determining the water hardness').



- i** The On/Off button also acts as a power switch. When the ENA is switched off, the machine does not consume standby energy.

⚠ WARNING



If the machine is operated with a defective mains cable, there is a danger of potentially fatal electric shock.

- ▶ Never use a machine which is damaged or has a defective mains cable.













Precondition: Bean container is filled.

- ▶ Insert the mains plug into a power socket.
- 🔌 ▶ Press the On/Off button to switch the machine on.
The Descaling symbol  and the Filter symbol  are lit up.
- i** Now decide whether you want to operate your ENA **with** or **without** a CLARIS Blue filter cartridge.

First-time use with filter cartridge activation







-  ▶ Touch the Filter symbol.
The Water Tank symbol  lights up.
- ▶ Remove the water tank.
- ▶ Open the filter holder.
- ▶ Insert the filter cartridge into the water tank, exerting slight pressure.















- ▶ Close the filter holder. It will click into place audibly.
- i** After two months, the filter will cease to work. Set the date on the date plate on the filter holder in the water tank.
- ▶ Fill the water tank with fresh, cold water and reinsert it.
- The Filter symbol  lights up.
-  ▶ Touch the Filter symbol.
The ,  and  symbols flash. The filter is rinsed and the water flows directly into the drip tray.
Rinsing of the filter stops automatically. The machine heats up.
The ,  and  symbols flash. The machine is rinsed, water flows out of the coffee spout. The rinse stops automatically.
The Coffee Grounds Container symbol  lights up.
- ▶ Empty the coffee grounds container and drip tray and rinse with warm water.
- ▶ Reinsert the coffee grounds container and the drip tray.
The Ristretto , Espresso  and Coffee  symbols and the symbol for 'strong' coffee strength  light up. Your ENA is ready for use.



First-time use without filter cartridge activation

If you do not want to use the CLARIS Blue filter cartridge, you will need to set the water hardness. The following water hardness settings are available:







Water hardness	Symbol(s) shown in display
Level 1: 1–15 °dH	1 symbol illuminated 
Level 2: 16–23 °dH	2 symbols illuminated  
Level 3: 24–30 °dH	3 symbols illuminated   

-  ▶ Touch the Descaling symbol. The ,  and  symbols light up.
- ▶ Touch the ,  or  symbol to set the water hardness, e.g. symbol  for 'level 1'. The  and  symbols light up.
-  ▶ Touch the Descaling symbol. The Water Tank symbol  lights up.
- ▶ Place a receptacle under the coffee spout.
- ▶ Remove the water tank.
- ▶ Fill the water tank with fresh, cold water and reinsert it.



The ,  and  symbols flash. The system fills with water and the water flows directly into the drip tray.

The operation stops automatically. The machine heats up.

The ,  and  symbols flash. The machine is rinsed, water flows out of the coffee spout. The rinse stops automatically. The Ristretto , Espresso , Coffee  and Coffee strength 'strong'  symbols light up. Your ENA is ready for use.

Filling the water tank

Daily maintenance of the machine and hygiene when handling coffee and water are key to a perfect coffee result in the cup every time. You should therefore change the water **daily**.

CAUTION

Milk, sparkling mineral water or other liquids can damage the water tank or the machine.

- ▶ Only fill the water tank with fresh, cold water.
- ▶ Remove the water tank and rinse with cold water.



- ▶ Fill the water tank with fresh, cold water and reinsert it.

Determining the water hardness

You can find out what the water hardness is by using the Aquadur® test strip supplied as standard.

- ▶ Hold the test strip briefly (for one second) under running water.
- ▶ Shake off the water.
- ▶ Wait for about one minute.
- ▶ You will then be able to read the degree of water hardness from the discolouration of the Aquadur® test strip and the description on the packaging.

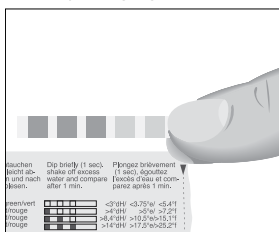

The water hardness can now be set.

2 Preparation

- i** While a speciality coffee is being prepared, you can stop preparation at any time. Simply touch the symbol for the product in question.
- i** If preparing two speciality coffees, you have to stop each brewing operation separately.
- i** Before and during the grinding operation you can select the **coffee strength** of the ristretto ☞, espresso ☞ and coffee ☞ speciality coffees: 'normal' (☉), 'strong' (☼).

The machine always uses the **preset amount of water** for the type of coffee in question. You can change this setting (see Chapter 2 'Preparation – Permanently setting the amount of water for the cup size').

Your ENA has an **Energy Save Mode**: Soon after the last preparation, the ENA stops heating up. To indicate that the machine is in energy-saving mode, after about 5 minutes the brightness of all the symbols is reduced. The ENA must heat back up before the next preparation.

Coffee tastes best served hot. A cold porcelain cup cools the beverage – and impairs the taste. We therefore recommend prewarming the cups. The full coffee aroma can develop only in prewarmed cups. You can purchase a JURA cup warmer from your specialised dealer.

Rotating coffee spout

Your ENA has a rotating coffee spout for preparing **one or two cups** of your desired speciality coffee:

- '1 cup' position



- '2 cups' position



- i** The two coffee spout positions clearly engage.
- i** If the coffee spout is in the '2 cups' position, the desired speciality coffee is prepared twice in succession. The coffee strength can only be set before the first product is prepared.

Ristretto, espresso and coffee

Ristretto ☞, espresso ☞ and coffee ☞ are prepared following this model.

Example: Proceed as follows to prepare one coffee.

Precondition: Your ENA is ready for use.

- ▶ Turn the coffee spout to the '1 cup' position.



- ▶ Place a cup under the coffee spout.
- ☞ ▶ Touch the Coffee symbol to start preparation. The Coffee ☞ and Coffee strength (☉ or ☼) symbols flash, the preset amount of water flows into the cup. Preparation stops automatically. Your ENA is once more ready for use.
- i** To prepare **two coffees**, turn the coffee spout to the '2 cups' position. Press the Coffee symbol ☞ to start preparation of two cups.

Permanently setting the amount of water for the cup size

It is easy to make permanent settings for the amount of water for all speciality coffees according to the cup size. Adjust the amount once as shown in the following example. Every time you prepare a drink in the future, this amount of water will be dispensed.











- i** The process for adapting the amount of water to the cup size only works when **preparing one cup**. When two cups are prepared, the set amount is doubled.

Example: Permanently adjust the amount of espresso to the cup size.

Precondition: Your ENA is ready for use.

- ▶ Turn the coffee spout to the '1 cup' position.



- ▶ Place a cup under the dual spout.
-  ▶ Touch the Espresso symbol **for about 3 seconds** until the Ristretto  and Coffee  symbols appear again.
-  ▶ **Release** the Espresso symbol. The espresso is prepared. The Espresso  and Coffee strength symbols ( or ) flash.
-  ▶ Touch the Espresso symbol as soon as there is enough espresso in the cup. Preparation stops. The amount of water for one espresso is permanently stored. The Espresso  and Coffee strength symbols ( or ) flash until the machine is ready for use again.
- i** You can alter this setting at any time by repeating the above procedure.

Adjusting the grinder

You can adjust the grinder on a continuous scale to suit the degree of roast of your coffee.

CAUTION

If you adjust the consistency of grind when the grinder is not operating, the grinder adjustment switch could be damaged.

- ▶ Only adjust the consistency of grind when the grinder is running.

- i** For a coarser consistency of grind, turn the switch to the left, for a finer grind, turn it to the right.

The consistency of grind is correct if the coffee flows regularly from the coffee spout. In addition a fine, thick crema forms.



Example: Change the consistency of grind **during** the preparation of a 'strong' espresso.

- ▶ Turn the coffee spout to the '1 cup' position.

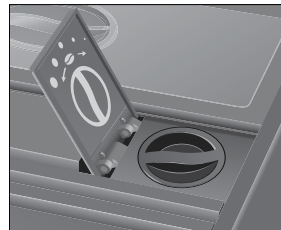

- ▶ Place a cup under the coffee spout.
- ▶ Open the cover of the grinder adjustment switch.



-  ▶ Touch the Coffee strength 'strong' symbol. The Coffee strength 'strong'  symbol lights up.

- ☞ ▶ Touch the Espresso symbol to start preparation.
- ▶ Turn the grinder adjustment switch to the desired position **while** the grinder is running.
The preset amount of water flows into the cup. Preparation stops automatically.
- i** Please note that changing the consistency of grind only takes effect for the second coffee preparation.

Ground coffee

You can choose to use a second coffee variety, for example decaffeinated coffee, with the powder chute for ground coffee.

- i** Use ground coffee which is not ground too finely. Very fine coffee can block up the system so that the coffee only comes out in drips.
- i** It is not possible to prepare two cups with ground coffee. If the coffee spout is in the '2 cups' position, just one cup is prepared.
- i** Never add more than one level measuring spoon of ground coffee.
- i** The desired speciality coffee must be prepared within approximately one minute after filling with the ground coffee. Otherwise the ENA stops the operation and is once more ready for use.
- i** If you did not add a sufficient amount of ground coffee, the ☞, ☞, ☞ and ☞ symbols flash and the ENA stops the operation.

All speciality coffees with ground coffee are prepared following this model.

Example: Prepare a cup of coffee using ground coffee.

Precondition: Your ENA is ready for use.

- ▶ Place a cup under the coffee spout.
- ▶ Open the powder chute for ground coffee.
The Ground Coffee symbol ☞ lights up.

- ▶ Place the filler funnel for ground coffee on the powder chute.

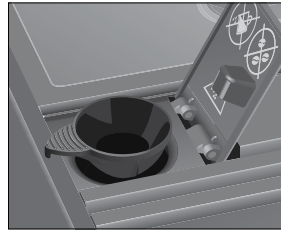

- ▶ Place one level measuring spoon of ground coffee into the filler funnel.
- ▶ Close the powder chute for ground coffee. The ☞, ☞, ☞ and ☞ symbols flash. The ☞, ☞ and ☞ symbols light up.
- ☞ ▶ Touch the Coffee symbol to start preparation.
The Coffee symbol ☞ flashes, the preset amount of water flows into the cup. Preparation stops automatically. Your ENA is once more ready for use.

3 Daily operation

Switching on the machine

Daily maintenance of the machine and hygiene when handling coffee and water are key to a perfect coffee result in the cup every time. You should therefore change the water **daily**.

When the machine is switched on, it is automatically rinsed.

- ▶ Place a receptacle under the coffee spout.
- ☞ ▶ Press the On/Off button to switch the machine on.
The ☞, ☞ and ☞ symbols flash, the machine heats up.
The machine is rinsed, water flows out of the coffee spout. The rinse stops automatically. Your ENA is ready for use.

Daily maintenance

To ensure that you get many years of reliable service out of your ENA and to guarantee the optimum coffee quality, the machine requires daily maintenance.

- ▶ Remove the drip tray.
- ▶ Empty the coffee grounds container and drip tray and rinse with warm water.



i Always empty the coffee grounds container when the machine is **switched on**. This is the only way of resetting the coffee grounds counter.

- ▶ Reinsert the coffee grounds container and the drip tray.
- ▶ Rinse the water tank with clean water.
- ▶ Wipe the surface of the machine with a clean, soft, damp cloth (e.g. microfibre cloth).

Switching off the machine

When the ENA is switched off, the system is automatically rinsed if a speciality coffee has been prepared.

- ▶ Place a receptacle under the coffee spout.
- ▶ Press the On/Off button.

The ,  and  symbols flash. The machine is rinsed, water flows out of the coffee spout.

The rinse stops automatically. Your ENA is switched off.

i When the ENA is switched off with the On/Off button, the machine does **not consume standby energy**.

i If no action is performed on the machine for 2 hours, the ENA will **automatically** switch off to save energy.



4 Permanent settings in programming mode





Inserting and activating the filter

Your ENA no longer has to be descaled if you are using the CLARIS Blue filter cartridge. If you did not activate the filter cartridge the first time you used the machine, you can do this now as follows.

i Perform the ‘inserting the filter’ operation without any interruptions. This will ensure that your ENA always produces its best.

Precondition: Your ENA is ready for use.

- ▶ Touch the  and  symbols for **approximately 2 seconds**.

The , ,  and  symbols light up brightly.

- ▶ Touch the Filter symbol  for **approximately 2 seconds**.

The Water Tank symbol  lights up.

- ▶ Remove the water tank.
- ▶ Open the filter holder.
- ▶ Insert the filter cartridge into the water tank, exerting slight pressure.

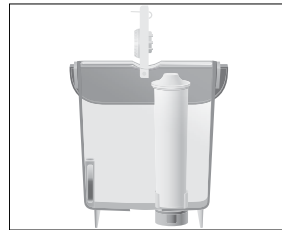











- ▶ Close the filter holder. It will click into place audibly.

i After two months, the filter will cease to work. Set the date on the date plate on the filter holder in the water tank.

- ▶ Fill the water tank with fresh, cold water and reinsert it.

The Coffee Grounds Container symbol  lights up.







- ▶ Empty the drip tray and coffee grounds container and reinsert them.
The Filter symbol  lights up.
-  ▶ Touch the Filter symbol to start rinsing of the filter
The , ,  and  symbols flash. The filter is rinsed.
Rinsing of the filter stops automatically. The Coffee Grounds Container symbol  lights up.
- ▶ Empty the drip tray and coffee grounds container and reinsert them.
The ,  and  symbols flash, the machine heats up. Your ENA is once more ready for use.





Setting the water hardness

- i** If you are using the CLARIS Blue filter cartridge and have activated it, there is no need to set the water hardness.















The harder the water is, the more frequently the ENA needs to be descaled. It is therefore important to set the water hardness accurately.

The following water hardness settings are available:

Water hardness	Symbol(s) shown in display
Level 1: 1–15 °dH	1 symbol illuminated 
Level 2: 16–23 °dH	2 symbols illuminated  
Level 3: 24–30 °dH	3 symbols illuminated   

Example: Change the water hardness setting from 'level 2' ( ) to 'level 3' (  ).

Precondition: Your ENA is ready for use.

- ▶ Touch the  and  symbols for **approximately 2 seconds**.
The , ,  and  symbols light up brightly.
-  ▶ **Briefly** touch the Descaling symbol.
The  and  symbols light up.
-  ▶ Touch the Coffee symbol.
The , ,  and  symbols light up.

-  ▶ Touch the Descaling symbol to confirm that you want to set the water hardness to 'level 3'.
Your ENA is once more ready for use.

5 Maintenance

Your ENA has the following integrated maintenance programmes:

- Cleaning the machine
- Descaling the machine
- Changing the filter

Cleaning the machine

After 180 preparations or 80 switch-on rinses, the ENA will prompt you to clean it.

CAUTION

If the wrong cleaning agent is used, the machine could be damaged and/or traces could be left behind in the water.

- ▶ Use only original JURA maintenance products.

- i** The cleaning programme lasts approximately 15 minutes.
- i** Do not interrupt the cleaning programme. The quality of cleaning will be impaired if you do so.
- i** JURA cleaning tablets are available from specialised dealers.

Precondition: Your ENA is ready for use. The Cleaning symbol  lights up.

- ▶ Turn the coffee spout to the '2 cups' position.



- ☼ ▶ Touch the Cleaning symbol for **approximately 2 seconds**.
The Coffee Grounds Container symbol ☼ lights up.
- ▶ Empty the drip tray and coffee grounds container and reinsert them.
The Cleaning symbol ☼ lights up.
- ▶ Place a receptacle under the coffee spout.
- ☼ ▶ Touch the Cleaning symbol.
The ☼, ☼, ☼ and ☼ symbols flash, water flows out of the coffee spout.
The operation is interrupted, the Ground Coffee symbol ☼ lights up.
- ▶ Open the powder chute for ground coffee and drop in a JURA cleaning tablet.

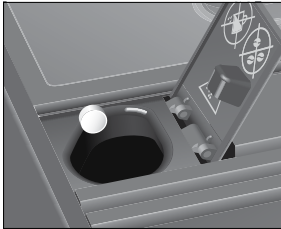

- ▶ Close the powder chute for ground coffee.
The Cleaning symbol ☼ lights up.
- ☼ ▶ Touch the Cleaning symbol.
The ☼, ☼, ☼ and ☼ symbols flash, water flows out of the coffee spout several times.
The operation is interrupted, the Coffee Grounds Container symbol ☼ lights up.
- ▶ Empty the drip tray and coffee grounds container and reinsert them.
The ☼, ☼ and ☼ symbols flash. The machine heats up.
Your ENA is once more ready for use.

Cleaning the machine without a prompt: You can initiate the 'Cleaning the machine' operation manually at any time as long as the machine is ready for use. Touch the ☼ and ☼ symbols **simultaneously for approx. 2 seconds**. The ☼, ☼, ☼ and ☼ or ☼ symbols light up brightly. Continue with the **first prompt** (indicated by ▶) as described in this section.

Descaling the machine

The ENA builds up deposits of limescale over time and automatically prompts you to descale it when necessary. The degree of calcification depends on the hardness of your water.

⚠ CAUTION

If the descaling agent comes into contact with the skin or eyes, this can cause irritation.

- ▶ Avoid contact with the skin or eyes.
- ▶ Rinse off the descaling agent with clean water. Should you get any descaling agent in your eye, see a doctor.

CAUTION

If the wrong descaling agent is used, the machine could be damaged and/or traces could be left behind in the water.

- ▶ Use only original JURA maintenance products.

CAUTION

If the descaling operation is interrupted, there may be damage to the machine.

- ▶ Allow the descaling programme to run to the end.

CAUTION

If the descaling agent comes into contact with sensitive surfaces (e.g. marble), damage cannot be ruled out.

- ▶ Clean up any splashes immediately.

- i** The descaling programme lasts approximately 40 minutes.
- i** JURA descaling tablets are available from specialised dealers.
- i** If you use a CLARIS Blue filter cartridge and this is activated, you will not be prompted to descale.

Precondition: Your ENA is ready for use. The Descaling symbol ☼ lights up.

- ▶ Touch the Descaling symbol ☼ for **approximately 2 seconds**.
The Coffee Grounds Container symbol ☼ lights up.



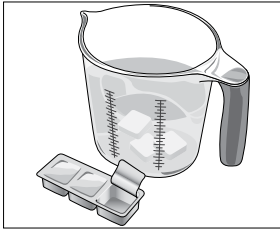

- ▶ Empty the drip tray and coffee grounds container and reinsert them. The Water Tank symbol  flashes.
- ▶ Remove and empty the water tank.
- ▶ Completely dissolve the contents of one blister (three JURA descaling tablets) in a receptacle holding 500 ml of water. This may take several minutes.





- ▶ Pour the solution into the **empty** water tank and reinsert the tank.

The Descaling symbol  lights up.

- ▶ Touch the Descaling symbol.





The , ,  and  symbols flash, water flows directly into the drip tray.



The operation is interrupted, the Coffee Grounds Container symbol  flashes.

- ▶ Empty the drip tray and coffee grounds container and reinsert them. The Water Tank symbol  lights up.
- ▶ Remove the water tank and **rinse thoroughly**.
- ▶ Fill the water tank with fresh, cold water and reinsert it.

The Descaling symbol  lights up.

- ▶ Touch the Descaling symbol.







The , ,  and  symbols flash, water flows directly into the drip tray.

The ,  and  symbols flash, water flows out of the drip tray.

The operation is interrupted, the Coffee Grounds Container symbol  lights up.

- ▶ Empty the drip tray and coffee grounds container and reinsert them. Your ENA is once more ready for use.

- i** If the descaling operation stops unexpectedly, rinse the water tank thoroughly.

Descaling the machine without a prompt: You can initiate the 'Descaling the machine' operation manually at any time as long as the machine is ready for use. Touch the  and  symbols **simultaneously for approx. 2 seconds**. The , ,  and  symbols light up brightly. Continue with the **first prompt** (indicated by ) as described in this section.

Changing the filter

- i** After 50 litres of water have flowed through, the filter will cease to work. Your ENA will automatically prompt you to change the filter.
- i** After two months, the filter will cease to work. Set the date on the date plate on the filter holder in the water tank.
- i** If the CLARIS Blue filter cartridge is not activated in programming mode, you will not be prompted to change the filter.









Precondition: Your ENA is ready for use. The Filter symbol  lights up.







- ▶ Touch the Filter symbol **for approximately 2 seconds**. The Water Tank symbol  lights up.
- ▶ Remove the water tank.
- ▶ Open the filter holder and remove the old filter cartridge.
- ▶ Insert a new filter cartridge into the water tank, exerting slight pressure.



- ▶ Close the filter holder. It will click into place audibly.
- i** After two months, the filter will cease to work. Set the date on the date plate on the filter holder in the water tank.

5 Maintenance

- ▶ Fill the water tank with fresh, cold water and reinsert it.
The Coffee Grounds Container symbol  lights up.
- ▶ Empty the drip tray and coffee grounds container and reinsert them.
The Filter symbol  lights up.
-  ▶ Touch the Filter symbol to start rinsing of the filter.
The , ,  and  symbols flash. The filter is rinsed. Water flows directly into the drip tray.
Rinsing of the filter stops automatically. The Coffee Grounds Container symbol  lights up.
- ▶ Empty the drip tray and coffee grounds container and reinsert them.
The machine heats up. Your ENA is once more ready for use.

Changing the filter without a prompt: If the filter is activated, you can initiate the 'Changing the filter' operation manually at any time as long as the machine is ready for use. Touch the  and  symbols simultaneously for approx. 2 seconds. The , ,  and  symbols light up brightly. Continue with the **first prompt** (indicated by ) as described in this section.

Descaling the water tank

Limescale deposits may form in the water tank. To ensure correct function of the machine, descale the water tank from time to time.



















- ▶ Remove the water tank.
- ▶ If you use a CLARIS Blue filter cartridge, remove it.
- ▶ Descale the tank with a mild conventional descaling agent in accordance with the manufacturer's instructions.
- ▶ Rinse the water tank thoroughly.
- ▶ If you use a CLARIS Blue filter cartridge, reinsert it.
- ▶ Fill the water tank with fresh, cold water and reinsert it.

Cleaning the bean container







Coffee beans may be covered with a slight oil film which remains on the walls of the bean container. These traces may negatively affect the coffee result. For this reason clean the bean container from time to time.

-  ▶ Press the On/Off button to switch the machine off.
- ▶ Disconnect the mains plug.
- ▶ Remove the bean container cover.
- ▶ Remove the coffee beans with a vacuum cleaner.
- ▶ Clean the bean container with a soft, dry cloth.
- ▶ Fill the bean container with fresh coffee beans, then close the bean container cover.

6 Messages on symbol display

Message (Symbol(s) shown in display)	Cause/Result	Action
The Water Tank symbol  lights up.	The water tank is empty or not correctly inserted. You cannot prepare any products.	<ul style="list-style-type: none"> ▶ Fill the water tank (see Chapter 1 'Preparing and using for the first time – Filling the water tank'). ▶ Insert the water tank.
The Coffee Grounds Container symbol  lights up.	The coffee grounds container is full. No speciality coffees can be prepared.	▶ Empty the coffee grounds container and the drip tray (see Chapter 3 'Daily operation – Daily maintenance').
The Coffee Grounds Container symbol  flashes.	The drip tray is not inserted correctly or is not inserted at all. You cannot prepare any products.	▶ Insert the drip tray.
The  ,  ,  ,  and  symbols flash.	The aroma preservation cover for the bean container is not fitted or not fitted correctly.	▶ Fit the aroma preservation cover correctly.
The  ,  ,  and  or  symbols light up brightly.	You are in programming mode.	▶ Touch the  or  symbol to exit programming mode. Your ENA is once more ready for use.
The ENA is ready for use and the Cleaning symbol  lights up.	The ENA is prompting you to clean it.	▶ Perform cleaning (see Chapter 5 'Maintenance – Cleaning the machine').
The ENA is ready for use and the Descaling symbol  lights up.	The ENA is prompting you to descale it.	▶ Perform descaling (see Chapter 5 'Maintenance – Descaling the machine').
The ENA is ready for use and the Filter symbol  lights up.	After 50 litres of water have flowed through the CLARIS Blue filter cartridge, it will cease to work.	▶ Replace the CLARIS Blue filter cartridge (see Chapter 5 'Maintenance – Changing the filter').
Preparing ground coffee: after ground coffee is added to the machine, the  ,  ,  and  symbols flash briefly.	There is insufficient ground coffee in the machine; the ENA stops the operation.	▶ The next time you prepare a beverage, add more ground coffee (see Chapter 2 'Preparation – Ground coffee').

7 Troubleshooting

Problem	Cause/Result	Action
Coffee only comes out in drips when it is being prepared.	Coffee or ground coffee has been ground too finely and is blocking the system.	▶ Set the grinder to a coarser setting or use coarser ground coffee (see Chapter 2 'Preparation – Adjusting the grinder').
The Water Tank symbol  lights up even though the tank is full.	The water tank float is trapped.	▶ Descal the water tank (see Chapter 5 'Maintenance – Descaling the water tank').
The  and  symbols flash alternately.	The system must be filled with water.	▶ Fill the water tank (see Chapter 1 'Preparing and using for the first time – Filling the water tank'). ▶ Touch the  or  symbol. The system fills up with water.
Grinder is making a very loud noise.	There are foreign objects in the grinder.	▶ Contact customer support in your country (see Chapter 11 'JURA contact details / Legal information').
When the ENA is switched on, the Cleaning symbol  flashes for 5 seconds. The machine then switches off.	If the machine was exposed to the cold for a long period of time, heating is disabled for safety reasons.	▶ Warm the machine at room temperature.
When the ENA is switched on, one of the symbols (other than ) flashes for 5 seconds. The machine then switches off.	–	▶ Contact customer support in your country (see Chapter 11 'JURA contact details / Legal information').

i If you were unable to solve the problem, contact customer support in your country (see Chapter 11 'JURA contact details / Legal information').

8 Transport and environmentally friendly disposal

Transport / Emptying the system

Keep the packaging for your ENA. It should be used to protect the machine during transport.

In order to protect the ENA from frost during transport, the system must be emptied.

Precondition: Your ENA is ready for use.

- ▶ Place a receptacle under the coffee spout.
- ▶ Touch the ☉ and ☼ symbols for **approximately 2 seconds**.

The ☉, ☼, ☽ and ☿ or ☽ symbols light up brightly.

- ▶ Remove and empty the water tank.

The ☽, ☽ and ☽ symbols light up.

- ☽ ▶ Touch the Espresso symbol.

Hot water will continue to flow until the system is empty.

The Water Tank symbol ☽ lights up.

- ☽ ▶ Press the On/Off button to switch the machine off.

Disposal

Please dispose of old machines in an environmentally neutral way.



Old machines contain valuable, recyclable materials which should be recycled. Please therefore dispose of old machines via suitable collection systems.

9 Technical data

Voltage	220–240 V ~, 50 Hz
Power	1450 W
Conformity mark	CE Ⓢ
Energy consumption Energy Save Mode 'on' (display symbols slightly less bright)	approx. 4.0 Wh
Pump pressure	Static, max. 15 bar
Holding capacity of water tank (without filter)	1.1 l
Holding capacity of bean container	125 g
Holding capacity of coffee grounds container	approx. 9 servings
Cable length	approx. 1.1 m
Weight	approx. 8.9 kg
Dimensions (W × H × D)	23 × 32.3 × 44.5 cm

Information for testers (repeat test in accordance with DIN VDE 0701-0702): The central grounding point (CGP) is located on the underside of the machine, right next to the mains cable's connection point.

10 Index

A

- Addresses 50
- Aroma preservation cover
 - Bean container with aroma preservation cover 30

B

- Bean container
 - Bean container with aroma preservation cover 30
 - Cleaning 44
 - Filling 34
- Bus bar
 - Technical data 47
- Button
 - On/Off button 30

C

- Central grounding point 47
- CLARIS Blue filter cartridge
 - Changing 43
 - Inserting and activating the filter 40
- Cleaning
 - Bean container 44
 - Machine 41
- Coffee 37
- Coffee grounds container 30
- Coffee spout
 - Rotating coffee spout 30, 37
- Consistency of grind
 - Adjusting the grinder 38
 - Grinder adjustment switch 31
- Contact details 50
- Cup grille 30
- Customer support 50

D

- Descaling
 - Machine 42
 - Water tank 44
- Display
 - Symbol display 31
- Display, messages 45
- Disposal 47
- Drip tray 30

E

- Emptying the system 47
- Energy Save Mode 37
- Errors
 - Troubleshooting 46
- Espresso 37

F

- Filling
 - Bean container 34
 - Water tank 36
- Filter
 - Changing 43
 - Inserting and activating the filter 40
- First-time use 35
 - With filter cartridge activation 35
 - Without filter cartridge activation 36

G

- Grinder adjustment switch 31
- Ground coffee 39
 - Powder chute for ground coffee 31
- Grounding point 47

H

- Hotline 50

I

- Instant coffee
 - Ground coffee 39
- Internet 34

J

- JURA
 - Contact details 50
 - Internet 34
 - website 34

M

- Machine
 - Cleaning 41
 - Descaling 42
 - Setting up 34
 - Switching off 40
 - Switching on 39
- Mains cable 30
- Maintenance 41
 - Daily maintenance 40
- Messages on display 45

P

- Permanently setting the water for the cup size 38
- Permanent settings in programming mode 40
- Powder chute
 - Powder chute for ground coffee 31
- Preparation 37
 - Coffee 37
 - Espresso 37
 - Ground coffee 39
 - Ristretto 37
- Problems
 - Troubleshooting 46
- Programming mode 40
 - Setting the water hardness 41
- Proper use 32

R

- Ristretto 37

S

- Safety 32
- Safety information 32
- Settings
 - Permanent settings in programming mode 40
- Setting up
 - Setting up the machine 34
- Switching off 40
- Switching on 39
- Symbol
 - Cleaning 31
 - Coffee 31
 - Coffee Grounds Container 31
 - Coffee strength 31
 - Descaling 31
 - Espresso 31
 - Filter 31
 - Ground Coffee 31
 - Ristretto 31
 - Water Tank 31
- Symbol description 29
- Symbol display 31
 - Messages 45

T

- Technical data 47
- Tel 50
- Transport 47
- Troubleshooting 46

U

- Use, First-time 35

V

- Ventilation slots 30

W

- Water hardness
 - Determining the water hardness 36
 - Setting the water hardness 41
- Water tank 30
 - Descaling 44
 - Filling 36
- website 34

11 JURA contact details / Legal information

11 JURA contact details / Legal information

JURA Elektroapparate AG
Kaffeeweltstrasse 10
CH-4626 Niederbuchsiten
Tel. +41 (0)62 38 98 233

@ You will find additional contact details for your country at www.jura.com.

Directives

The machine complies with the following directives:

- 2006/95/EC – Low Voltage Directive
- 2004/108/EC – Electromagnetic Compatibility
- 2009/125/EC – Ecodesign Directive
- 2011/65/EU – RoHs Directive

Technical changes

We reserve the right to make technical changes. The diagrams used in these instructions for use are for illustration purposes only and do not represent the original colours of the machine. Some details of your ENA may vary.

Feedback

Your opinion is important to us! Use the contact details at www.jura.com.

Copyright

The instructions for use contain information which is protected by copyright. It is not permitted to photocopy these instructions for use or translate them into another language without the prior written consent of JURA Elektroapparate AG.